



AFC Compact Systems: GEA Searle DSR Air Cooler

Top-level engineering solutions



For full selection data either refer to the Selection data tables or use the Searle selection software, either online or via your local GEA Searle representative.





Commercial Air Coolers

AFC Compact Systems

GEA Searle's wide range of commercial unit coolers guarantee the continued excellence of our product range in terms of innovation, design and performance to offer the ideal cooler at a competitive price. They are the 1st choice product for their proven design and reliability, the range comes with many benefits which is often utilised across many industries the applications include small and large cold rooms and cabinets, warehouses, food storage and preparation rooms, freezers and blast freezing.

For more information, please refer to our Selection Software program or selection data tables. Alternatively a fully interactive version of selection software is available online at www.searle.co.uk, where it is possible to view all brochures and Installation & Maintenance manuals.

Commercial Air Coolers general features

AFC Compact Systems



Motors & Fansets

GEA Searle selects the optimum combination of motors and fans to deliver the best performance for the cooler size and application range. All motors and fansets are verified for power input and air volume in our Research & Development department. Specific motor data details are provided in the relevant section for each cooler type.

EC

EC fansets offer the optimum in energy efficient performance combined with low noise levels and high reliability. The KEC and TEC Cooler range uses EC fansets as standard making them the most energy efficient cooler products available. Energy usage can be less than 50% of that of similar products, resulting in a product with a reduced payback period. Additional benefits include:-

- Internal motor protection
- Long service life
- High efficiency across the full operating range

For more information on EC fansets please see “Energy Efficient Fansets” in this catalogue

Casework

The standard GEA Searle cooler casework is white powder coated, oven cured at 180°C to provide a hard durable finish. The JG, KLe and NS coolers are manufactured using aluminium casework, while the TEC, KEC, KMe and DSR all utilise galvanised steel casing.

Blygold® Coating (Optional)

GEA Searle specialist coating facility, where a Blygold® coating is applied and cured to protect the finned coils against harsh environmental conditions such as erosion by sand or salt. It provides a barrier and avoids the risk of electrolytic reactions between the two metals involved. The coating contains aluminium, in order to maintain the thermal performance of the coil, resulting in an extension of the lifetime, maximum cooling capacity and reduction of energy costs. The coating is oriented in such a way that it creates a very high chemical resistance at low layer thickness.



The Blygold® concept is a revolutionary product created to prevent corrosion which will ultimately reduce energy costs.





The duties presented in the specification tables are nominal. Tests are conducted in accordance with EN 328 under dry conditions which allows performance to stabilise and permits measurement over a prolonged period. The wet catalogue capacities are calculated from the dry capacities using the ratios given in the Eurovent Standard 7/C/001.

Refrigeration	R404A	R134a	R507A	R407A/F	R407C
Capacity factor (dew point, DT1)	1.00	0.91	0.97	1.18*	1.35*
Refrigerant charge density (kg/dm ³)	0.312	0.338	0.313	0.332	0.332



*Dew point capacity factors for refrigerants with high glide apply only at the nominal rating condition. Mid point factors can be used for all conditions. Refrigerant Charge Densities based on 25% of the internal volume being liquid.



Commercial Air Coolers

AFC Compact Systems

Range benefits

The GEA Searle range of commercial unit coolers combine versatility and aesthetic design with consistent performance to offer the ideal cooler at a competitive price. They are typically the 1st choice product for the following applications due to their proven design and reliability :-

- Cold rooms
- Food storage
- Food preparation
- Cool cabinets

GEA Searle coolers are approved for many supermarkets across the world and are used extensively in convenience stores, commercial refrigeration applications and many industrial & agricultural projects.

Selection software

Due to the large number of models available and the range of alternative refrigerants, selection of the optimum cooler is best performed using the latest Searle Selection Software. The software can be obtained either as a CD, direct from your GEA Searle representative or downloaded from the GEA Searle website, where it is also possible to view all brochures and installation & maintenance data.

Energy efficient

With the increasing importance of energy efficiency as part of the selection criteria, the new GEA Searle coolers utilise fansets which offer significant energy savings over traditional motor assemblies. The KEC and TEC cooler have high efficiency EC fans as standard across the range.

Assured performance

All our commercial unit coolers where applicable are certified under the Eurovent Certify All™ programme to guarantee that every unit will perform as specified.

Availability



Many of the models in the commercial unit cooler ranges are available ex-stock from your local distributor, with backup stocks held at the UK manufacturing plant centre.

Backing our beliefs

We offer 24 months warranty on all products in the range, with 24 months warranty on all coolers (subject to standard Terms & Conditions of Sale and excluding corrosion through misapplication).

	Models	No fans	Configuration	Eurovent
	JG	1 - 3		
	TEC*	1 - 3		
	NS	1 - 4		
	KEC*	1 - 3		
	KMe	1 - 4		
	KLe	1 - 3		
	DSR*	1 - 4		

✓ Yes X No ○ Option

	Options							Capacity KW @ 8 KTD		
	Supply	EC Fans	Standard Electric Defrost	Heavy Electric Defrost	Hot Gas Defrost A/B/C/D	CO2	Fin Materials	1	10	100
	1 ph	X	✓ Kit	X	X	X	Al	0.3 - 1.6 kW		
	1 ph	✓	✓ Kit	X	X	X	Al	0.5 - 3.4 kW		
	1 ph	X	✓	X	X	X	Al	1.7 - 6.9 kW		
	1 ph	✓	✓	X	✓	✓	Al	1.2 - 10.5 kW		
	1 & 2 ph	O	✓	✓	✓	✓	Al	5.7 - 28 kW		
	3 ph	✓	✓	X	✓	✓	Al	8 - 51 kW		
	1 ph	X	✓	X	✓	✓	Al	0.8 - 15 kW		

Note: * See page 196 for CO2 variations of these coolers

DSR Air Cooler

AFC Compact Systems



DSR 42 -4 L

Range	DSR
Model	12,19,22,36,42,51,62,68,83,100,116
Fin spacing	3mm, 4mm, 6mm
Defrost	Blank = No defrost, L = Standard Electric Defrost
Fin Material	Al = Aluminium
Frequency	Blank = 50Hz, 60 = 60Hz

DSR Unit Cooler

The DSR range of low profile, low air velocity, ceiling mounted, dual discharge coolers has been designed for cold rooms, laboratories, food preparation areas and similar applications. The 11 DSR models have from one to four fans and are available in three fin spacings, providing capacities from 0.8kW to 15.1kW. Nine models have two speed motors and all can be fitted with optional speed control. DSR coolers are available for low temperature or high temperature applications. The revolutionary design combines compactness with efficiency and attractiveness, as well as accessibility and serviceability. The casework is white epoxy painted galvanised steel. The coil is made from 1/2" O/D internally grooved copper tube with mechanical bonding to the proven Searle 'D' fin available in 3mm, 4mm or 6mm spacing. For ease of installation, the wiring and drain connection can be from either end of the unit. The range calls on the experiences and designs of previous Searle coolers and provides the opportunity for close temperature control, with minimum energy demands from a compact, unobtrusive unit.



Casework

All external metalwork is finished in a white high gloss epoxy powder. The coil is supported by the coil end plates and supports which are in turn connected to the hanger brackets. These enable the cooler to be mounted flush to the ceiling. Efficient condensate drainage is achieved inside the unit by sloping inner drain trays, enabling the cooler to be mounted square to the ceiling. The drain assembly is reversible for convenience of installation. The DSR design includes a space allocation at the refrigerant connection end to allow the TEV to be housed inside the unit.

Corrosion Protection

The rigid case structure is fabricated from galvanised sheet steel. Paint is applied to external surfaces in GEA Searle's modern electrostatic powder paint plant then baked and cured at 180°C, ensuring an even, flexible and durable finish.

Coils and Coil Options

The coil block comprises 1/2" diameter copper tubes with an extended inner surface ensuring maximum heat transfer efficiency and minimum refrigerant charge. The tubes are mechanically expanded to form a tight interference fit into the collars of the aluminium fins. This efficient design reduces the cooler's physical size thus maximising storage capacity. Standard coils are tested to 35.8 bar before they leave the factory.

Cu/AL - Copper tubes with Aluminium fins, Cu/AV - Copper tubes with vinyl-coated, Aluminium fins (3mm and 4mm fin spacing), Coils circuited for glycol.



Motors and Fans

All DSR units utilise internally protected single phase squirrel cage motors of a totally enclosed, air cooled, permanent capacitor type in an IP44 enclosure. They are individually wired via plug and socket connectors and cable trays back to a robust junction box, where an electrical bridging facility is provided. High or low speed operation (excluding DSR 100 & 116) is obtained by connecting the electrical supply to the appropriate terminals. The motors on the DSR 100 & 116 are suitable for speed control via an optional Searle Triac controller

Models DSR 12 to DSR 83 use a 305mm propeller type five-bladed fan with a fractional dual speed 25W motor. A pitch of 24° is supplied for 50Hz applications and 20° for 60Hz. Models DSR 100 and DSR 116 are fitted with four-bladed 305mm fans and 70W single speed motors, running at 4-pole speed. A pitch of 32° is supplied for 50Hz applications and 26° for 60Hz.

Speed Control on DSR 100 & DSR 116 Speed control on DSR models 100 & 116 can be utilised to tailor air velocities to suit various applications - e.g to minimise possible personnel discomfort caused by airflow or noise. To achieve lower speeds on the single speed 70 Watt motors found on DSR100 and 116 models, Searle offers a manually operated, Triac type speed controller which must be ordered separately. Performances for a typical speed of 800rpm are given in the Selection data.

For other speeds, air flow and thermal performance are approximately proportional to speed. Operation at any speed between 600 rpm and maximum is approved.

Specification and Selection data

Noise Levels

The noise levels given in the tables are a guide to users where noise pollution is an important factor. The test figures are based on 'free field', defined as: 'unit mounted over a reflective plane with no other reflective surface'. Individual installations will have differing acoustic characteristics which will affect the noise levels. If noise is critical, advice should be sought from an acoustic consultant.

Defrost Options

Where electric defrost is specified, heater elements are installed beneath each coil block. Models DSR 100 and DSR 116 have an additional element within each coil. (A one metre space must be lowed at one end of these two models to facilitate element withdrawal). Hot gas defrost with electric drain pan heaters can also be specified. Low temperature operation is not recommended on the 3mm fin spacing option.

Natural defrost with fans operating is not suitable or coolers operating with a room temperature of less than 5°C. For applications below -20°C it is recommended that the optional sump heater is used.

Installation

Units are designed to be flush-mounted to the ceiling, using the brackets incorporated into the casework. Electrical and refrigeration connections are at opposite ends but provision has been made for the electrical cabling to be ducted through a channel to the refrigeration end if required. Access is provided for service connections through the top of the unit at each end. The drain tray assembly can be reversed, allowing the drain connection to be sited at the preferred end. The standard drain connection is a 3/4" BSP horizontal connection, 35mm long and welded to the end of the sump.

Serviceability

Serviceability and accessibility were paramount in the design of the DSR range. Access to components such as fans, motors and defrost heaters is simple and rapid through either the fan guard or heater covers/drain trays. Removable end panels enable easy access to the electrical junction box and refrigeration connections. Motors can be removed rapidly, due to a simple plug and socket connector and straightforward mounting plate.

Quality Assurance

Searle is a certified company to BS EN ISO 9001 which is the highest Quality Assurance qualification currently available, covering Performance Testing, Manufacturing Systems and Inspection Procedures.

Rating Conditions

The duties shown in this catalogue are at EN 328 Standard Condition 2 (-8°C saturated suction temperature, 0°C air entering).

Certification

The range is certified under the Eurovent CERTIFYALL direct expansion air coolers program, with performances tested in accordance with EN 328.

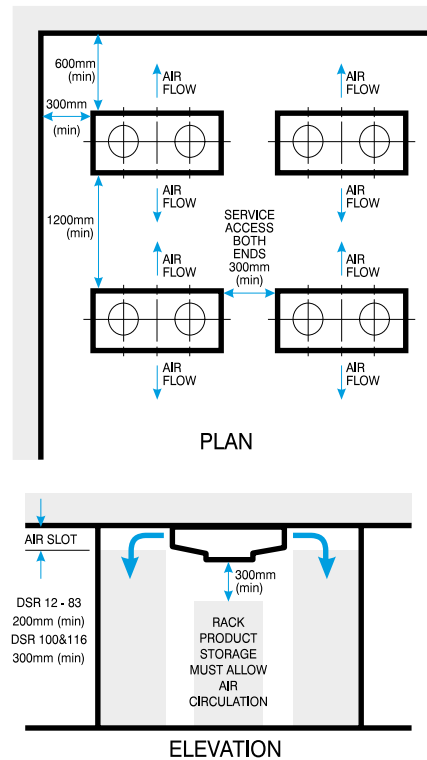

Location

The DSR is designed to draw air in the bottom and discharge it horizontally through the coils fitted on each side. For the best performance, the cooler should be placed at the geometric centre of the room or module in which it is operating.

Mounting

The DSR is primarily designed for flush ceiling mounting but may also be hung on rods. The cooler must be level in both horizontal directions to ensure free drainage of condensate.

Condensate Drainage

The horizontal drain connection is a 3/4" BSP(T) steel stub which is welded into the base of the drain sump. The drain line must pitch down with a minimum 2% gradient and must terminate outside the cold room with a 'U' trap seal.

TEV Selection

It is important that the TEV is sized correctly and that the valve is fitted directly onto the distributor inlet or as close to it as possible. The TEV should be sized for the maximum capacity at the minimum pressure drop across it, which occurs at the minimum condensing pressure. In addition, the following allowance must be made for the cooler's distributor and leads:

Distributor system pressure drop	
R404A, R507A, R407A	1.5 Bar
R134a	1.0 Bar

Externally equalised expansion valves should be used on all models except DSR12.

Standard (high speed)

Model	Capacity kW (SC2)	Motor details 230V - 1ph - 50Hz					Fan data			
	R404A	No. of fans	Total power input	FLC per fan	SC per fan	Speed	Air volume	Air throw	Noise level	
			*** W	amps	amps	RPM	m ³ /s	m	dB(A)	

3mm	DSR19-3	2.42	1	64	0.3	0.38	1325	0.31	11	49
	DSR22-3	2.88	1	64	0.3	0.38	1325	0.30	10	49
	DSR36-3	4.6	2	128	0.3	0.38	1325	0.60	12	51
	DSR42-3	5.29	2	128	0.3	0.38	1325	0.58	11	51
	DSR51-3	6.9	3	192	0.3	0.38	1325	0.90	12	54
	DSR62-3	7.82	3	192	0.3	0.38	1325	0.86	11	54
	DSR68-3	9.2	4	256	0.3	0.38	1325	1.20	12	55
	DSR83-3	10.58	4	256	0.3	0.38	1325	1.15	11	55
	DSR100-3	13.0	4	640	0.81	1.85	1420	1.65	10	60
DSR116-3	14.49	4	640	0.81	1.85	1420	1.47	9	60	
4mm	DSR19-4	2.14	1	64	0.3	0.38	1325	0.31	11	49
	DSR22-4	2.67	1	64	0.3	0.38	1325	0.30	11	49
	DSR36-4	4.06	2	128	0.3	0.38	1325	0.61	12	51
	DSR42-4	4.95	2	128	0.3	0.38	1325	0.59	11	51
	DSR51-4	6.15	3	192	0.3	0.38	1325	0.92	12	54
	DSR62-4	7.40	3	192	0.3	0.38	1325	0.88	11	54
	DSR68-4	8.19	4	256	0.3	0.38	1325	1.22	12	55
	DSR83-4	9.90	4	256	0.3	0.38	1325	1.18	11	55
	DSR100-4	11.96	4	640	0.81	1.85	1325	1.72	11	60
DSR116-4	13.70	4	640	0.81	1.85	1420	1.56	10	60	
6mm	DSR19-6	1.78	1	64	0.3	0.38	1325	0.32	11	49
	DSR22-6	2.29	1	64	0.3	0.38	1325	0.31	10	49
	DSR36-6	3.33	2	128	0.3	0.38	1325	0.63	12	51
	DSR42-6	4.22	2	128	0.3	0.38	1325	0.61	11	51
	DSR51-6	4.95	3	192	0.3	0.38	1325	0.94	12	54
	DSR62-6	6.35	3	192	0.3	0.38	1325	0.92	11	54
	DSR68-6	6.68	4	256	0.3	0.38	1325	1.25	12	55
	DSR83-6	8.44	4	256	0.3	0.38	1325	1.22	11	55
	DSR100-6	10.05	4	640	0.81	1.85	1420	1.84	12	60
DSR116-6	12.31	4	640	0.81	1.85	1420	1.72	11	60	

Low (Low speed)

3mm	DSR19-3	1.61	1	26	0.14	0.14	750	0.17	7	34
	DSR22-3	1.84	1	26	0.3	0.14	750	0.16	7	34
	DSR36-3	2.99	2	52	0.14	0.14	750	0.33	8	37
	DSR42-3	3.34	2	52	0.14	0.14	750	0.31	7	37
	DSR51-3	4.49	3	78	0.14	0.14	750	0.49	8	39
	DSR62-3	4.83	3	78	0.14	0.14	750	0.47	7	39
	DSR68-3	5.98	4	104	0.14	0.14	750	0.66	8	40
	DSR83-3	6.56	4	104	0.14	0.14	750	0.62	7	40
	DSR100-3 ▼	8.63	4	376	0.87	1.85	800	0.93	7	48
DSR116-3 ▼	9.43	4	376	0.87	1.85	800	0.86	7	48	
4mm	DSR19-4	1.46	1	26	0.14	0.14	750	0.17	7	34
	DSR22-4	1.67	1	26	0.14	0.14	750	0.16	7	34
	DSR36-4	2.76	2	52	0.14	0.14	750	0.34	8	37
	DSR42-4	3.18	2	52	0.14	0.14	750	0.32	7	37
	DSR51-4	4.06	3	78	0.14	0.14	750	0.50	8	39
	DSR62-4	4.79	3	78	0.14	0.14	750	0.49	7	39
	DSR68-4	5.52	4	104	0.14	0.14	750	0.67	8	40
	DSR83-4	6.41	4	104	0.14	0.14	750	0.65	7	40
	DSR100-4 ▼	8.23	4	376	0.87	1.85	800	0.98	7	48
DSR116-4 ▼	9.01	4	376	0.87	1.85	800	0.89	7	48	
6mm	DSR19-6	1.25	1	26	0.14	0.14	750	0.17	7	34
	DSR22-6	1.51	1	26	0.14	0.14	750	0.17	7	34
	DSR36-6	2.29	2	52	0.14	0.14	750	0.34	8	37
	DSR42-6	2.86	2	52	0.14	0.14	750	0.34	8	37
	DSR51-6	3.44	3	78	0.14	0.14	750	0.52	8	39
	DSR62-6	4.22	3	78	0.14	0.14	750	0.50	8	39
	DSR68-6	4.64	4	104	0.14	0.14	750	0.69	8	40
	DSR83-6	5.64	4	104	0.14	0.14	750	0.67	8	40
	DSR100-6 ▼	7.08	4	376	0.87	1.85	800	1.05	8	48
DSR116-6 ▼	8.44	4	376	0.87	1.85	800	0.98	7	48	

DSR Selection data, Drawings and Dimensions

Model	Coil data							Defrost 230V (4/6mm only)
	Total surface area m ²			Internal volume	Approx. ref charge	Connections		
	3mm	4mm	6mm	dm ³	kg	Inlet	Outlet	kW
DSR19	18.00	14.0	9.40	2.50	0.78	1/2"	5/8"	1.58
DSR22	27.00	21.0	14.0	3.75	1.02	1/2"	5/8"	1.58
DSR36	33.0	25.0	17.0	4.22	1.36	1/2"	7/8"	2.85
DSR42	49.0	37.0	26.0	6.34	2.04	1/2"	7/8"	2.85
DSR51	49.0	37.0	26.0	6.14	1.97	1/2"	7/8"	4.27
DSR62	74.0	56.0	38.0	9.22	2.96	1/2"	1 1/8"	4.27
DSR68	66.0	50.0	34.0	8.07	2.59	1/2"	1 1/8"	5.70
DSR83	98.0	75.0	51.0	12.10	3.89	1/2"	1 1/8"	5.70
DSR100	98.0	75.0	51.0	12.10	3.89	5/8"	1 3/8"	7.67
DSR116	148.0	112.0	77.0	18.14	5.53	5/8"	1 3/8"	7.67

Refrigeration	R404A	R134a	R507A	R407A/F	R407C
Capacity factor (dew point, DT1)	1.00	0.91	0.97	1.18*	1.35*
Refrigerant charge density (kg/dm ³)	0.312	0.338	0.313	0.332	0.332

* Dew point capacity factors for refrigeration with high glide apply only at the nominal rating condition. Mid point factors can be used for all conditions. Refrigerant Charge Densities based on 25% of the internal volume being liquid

Capacity

The duties presented in the specification tables are nominal capacities for operational (or "wet") conditions. They have been calculated from the tested 'dry' conditions, conducted in accordance with EN 328, using ratios as specified by Eurovent Standard 7/C/001 which are shown. Tests are conducted under dry conditions which allows performance to stabilise and permits measurements over a prolonged period. Please note that these ratios are already included in the performance data.

Standard condition	Air temp./ Evap. temp	Relative humidity	Ratio
SC1	10°C / °C	85%	1.35
SC2	0°C / -8°C	85%	1.15
SC3	-18°C / °C	95%	1.05
SC4	-25°C / -31°C	95%	1.00

DSR Cooler DT1 - WET

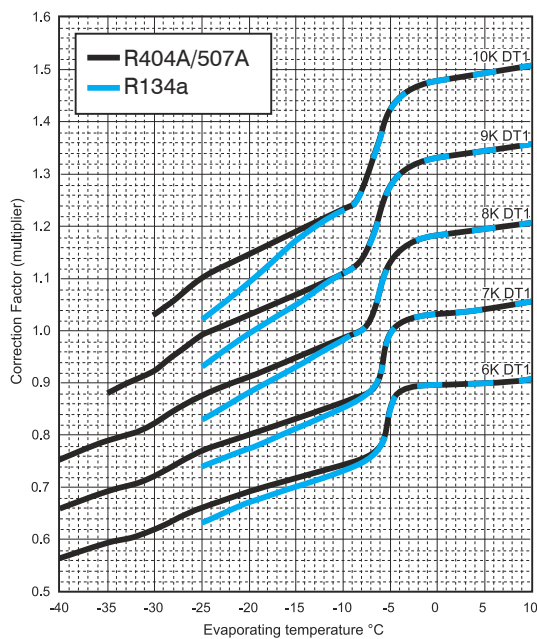

Correction Factors

(Multiply capacity by appropriate correction factor to give performance at chosen conditions).



End view

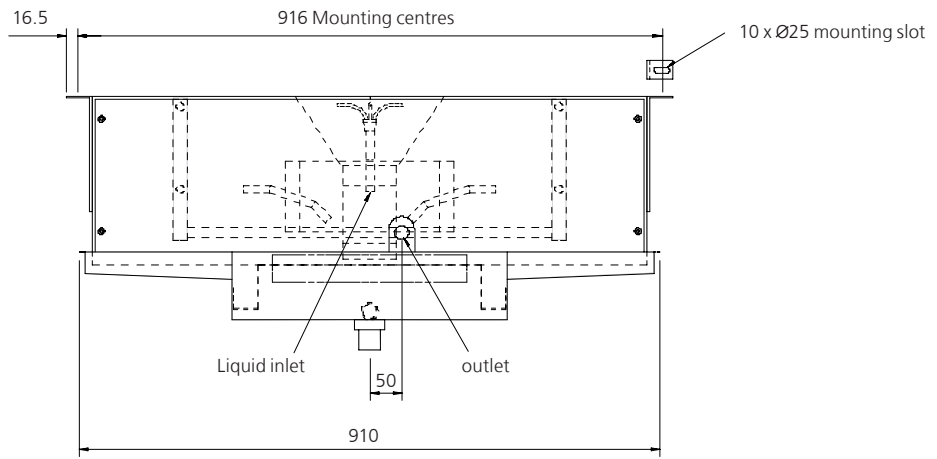

Side view

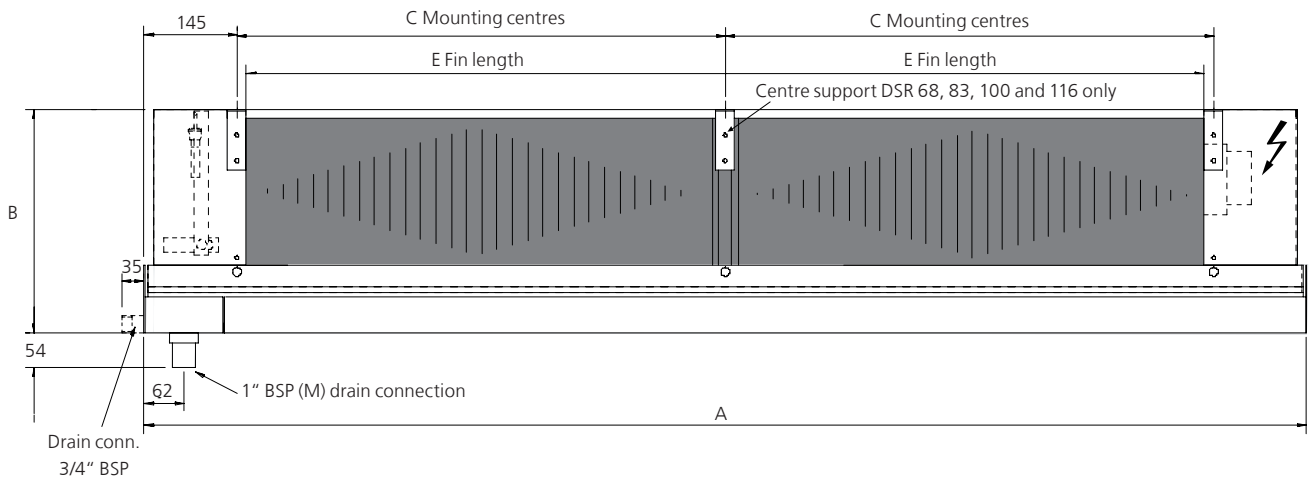

Model	Length mm	Depth mm	Fixing centres mm	Fin length mm	Dry weight (kg)		
	A	B	C	E	3mm	4mm	6mm
DSR19	870	266	580	550	57	56	56
DSR22	870	266	580	550	61	59	58
DSR36	1320	266	1030	1000	81	79	78
DSR42	1320	266	1030	1000	88	85	83
DSR51	1820	266	1530	1500	107	104	102
DSR62	1820	266	1530	1500	118	113	111
DSR68	2320	266	1015 x 2	2000	136	132	130
DSR83	2320	266	1015 x 2	2000	150	144	141
DSR100	2320	351	1015 x 2	2000	161	155	152
DSR116	2320	351	1015 x 2	2000	181	172	167



Excellence

Passion

Integrity

Responsibility

GEA-iversity

GEA Group is a global mechanical engineering company with multi-billion euro sales and operations in more than 50 countries. Founded in 1881 the company is one of the largest providers of innovative equipment and process technology. GEA Group is listed in the STOXX Europe 600 Index.



GEA Heat Exchangers

GEA Searle

20 Davis Way, Newgate Lane, Fareham, PO14 1AR
Tel. +44 (0) 1329 823344, Fax +44 (0) 1329 821242
sales@searle.co.uk, www.searle.co.uk